

PORTACARAMELLE / SWEET DISPENSER

PCBL

La caramelliera a bocca di lupo PCBL in Plexiglas® trasparente è la classica portacaramelle con coperchio basculante a scomparsa interna. E' disponibile nelle versioni a singola o multi buca, con o senza coperchi, ed è predisposta per l'inserimento della paletta di presa del prodotto sia confezionato che sfuso. E' adatta a contenere oltre alle caramelle e confetti, anche cereali, capsule del caffè, frutta secca, crocchette per animali, ecc....

Tutte le caramelliere sono in Plexiglas® corredate di CERTIFICATO di CONFORMITA' al contatto Alimentare (MOCA) secondo le normative CE.



The PCBL mouth sweet dispenser in transparent Plexiglas® is the classic sweet dispenser with internal tilting lid. It is available in single or multi-hole versions, with or without lids, and it has been designed for the insertion of the grip spoon as regards both packaged and loose product. It is suitable to contain not only candies and sugared almonds, but also cereals, coffee capsules, dried fruit, biscuits for pets, etc...

All sweet dispensers are in Plexiglas® and supplied with a CERTIFICATE OF CONFORMITY for food use (MOCA) according to the CE regulations.

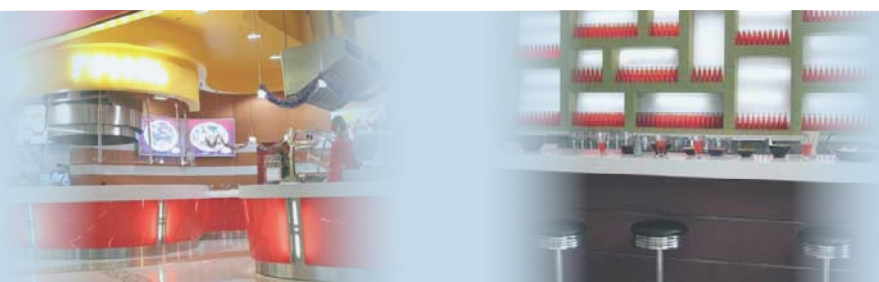

PORTACARAMELLE / SWEET DISPENSER

PCBL-SC 16 / PCBL-SA 16

PCBL-SC 16

Caramelliera a bocca di lupo singola con coperchio.

Single mouth sweet dispenser with lid.

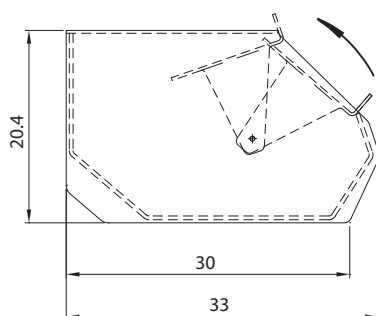
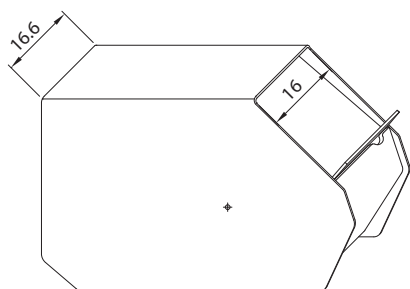

Ingombro massimo con perni 17,5 cm
overall dimension with pins 17,5 cm

La caramelliera si presta ad essere posizionata in modo sovrapposto ad altre, al fine di costituire una parete distributiva.

Sweet dispensers can be stacked to allow the building of a distribution wall.

PCBL-SA 16

Caramelliera a bocca di lupo singola senza coperchio.

Single mouth sweet dispenser without lid.

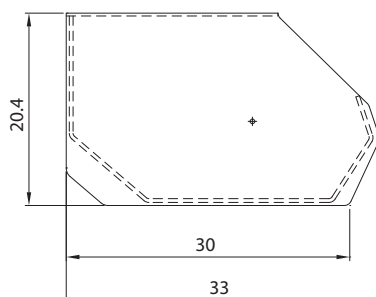
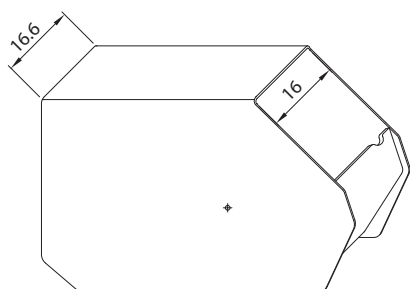

Tutte le caramelliere sono in Plexiglas® corredate di CERTIFICATO di CONFORMITA' al contatto Alimentare (MOCA) secondo le normative CE.

All sweet dispensers are in Plexiglas® and supplied with a CERTIFICATE OF CONFORMITY for food use (MOCA) according to the CE regulations.

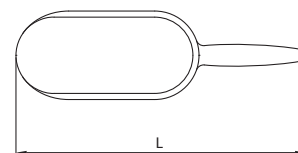

Palettina per alimenti bianca con CERTIFICATO di CONFORMITA' al contatto alimentare (MOCA)

White plastic spoon supplied with a CERTIFICATE of CONFORMITY for food use (MOCA)

PLT-19
PLT-24

L=19 cm
L=24 cm

PORTACARAMELLE / SWEET DISPENSER

PCBL-SC 20 / PCBL-SA 20

PCBL-SC 20

Caramelliera a bocca di lupo singola con coperchio.

Single mouth sweet dispenser with lid.

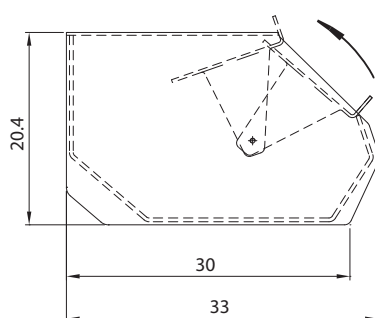
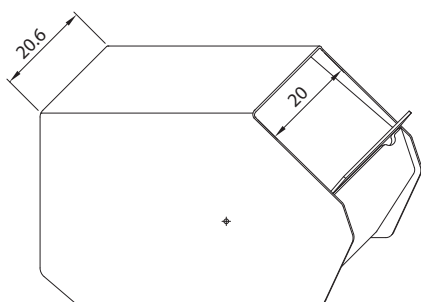

Ingombro massimo con perni 21,5 cm
overall dimension with pins 21,5 cm

La caramelliera si presta ad essere
posizionata in modo sovrapposto ad altre,
al fine di costituire una parete distributiva.

*Sweet dispensers can be stacked to allow the
building of a distribution wall.*

PCBL-SA 20

Caramelliera a bocca di lupo singola senza coperchio.

Single mouth sweet dispenser without lid.

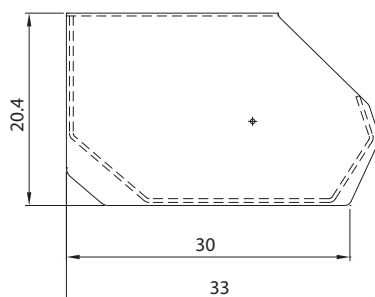
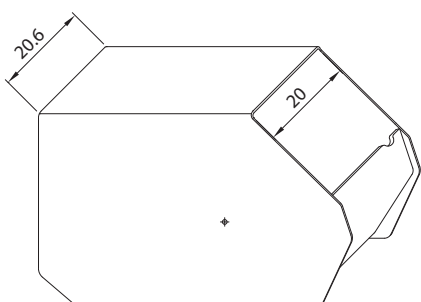

Tutte le caramelliere sono in Plexiglas® corredate di CERTIFICATO di CONFORMITA' al contatto Alimentare (MOCA) secondo le normative CE.

All sweet dispensers are in Plexiglas® and supplied with a CERTIFICATE OF CONFORMITY for food use (MOCA) according to the CE regulations.

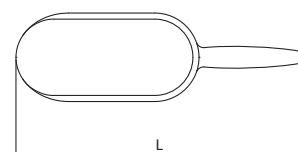

Palettina per alimenti bianca con
CERTIFICATO di CONFORMITA' al contatto alimentare (MOCA)

White plastic spoon supplied with a CERTIFICATE of CONFORMITY for food use (MOCA)

PLT-19
PLT-24

L=19 cm
L=24 cm

PORTACARAMELLE / SWEET DISPENSER

PCBL-MC 80-5 / PCBL-MA 80-5

PCBL-MC 80-5

Caramelliera a bocca di lupo multipla con coperchio.

Multiple mouth sweet dispenser with lid.

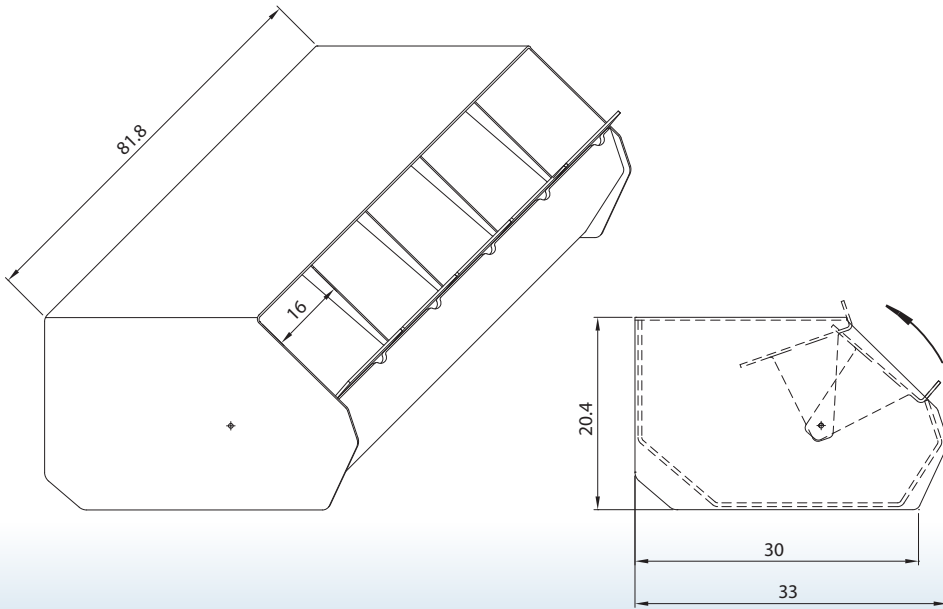

Nelle versioni a multibuca i coperchi si aprono singolarmente.

Lids can be opened individually in the multi-hole version.

La caramelliera si presta ad essere posizionata in modo sovrapposto ad altre, al fine di costituire una parete distributiva.

Sweet dispensers can be stacked to allow the building of a distribution wall.



PCBL-MA 80-5

Caramelliera a bocca di lupo multipla senza coperchio.

Multiple mouth sweet dispenser without lid.

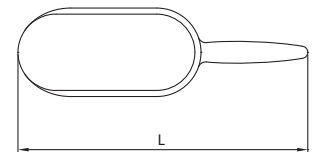
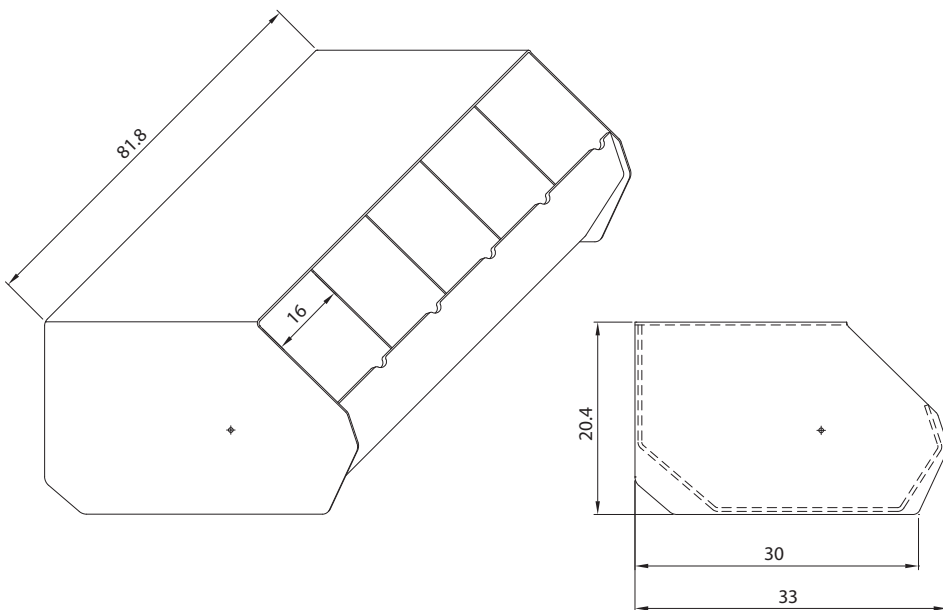

Palettina per alimenti bianca con CERTIFICATO di CONFORMITA' al contatto alimentare (MOCA)

White plastic spoon supplied with a CERTIFICATE of CONFORMITY for food use (MOCA)

PLT-19

L = 19 cm

PLT-24

L = 24 cm

Tutte le caramelliere sono in Plexiglas® corredate di CERTIFICATO di CONFORMITA' al contatto Alimentare (MOCA) secondo le normative CE.

All sweet dispensers are in Plexiglas® and supplied with a CERTIFICATE OF CONFORMITY for food use (MOCA) according to the CE regulations.

PORTACARAMELLE / SWEET DISPENSER

PCBL

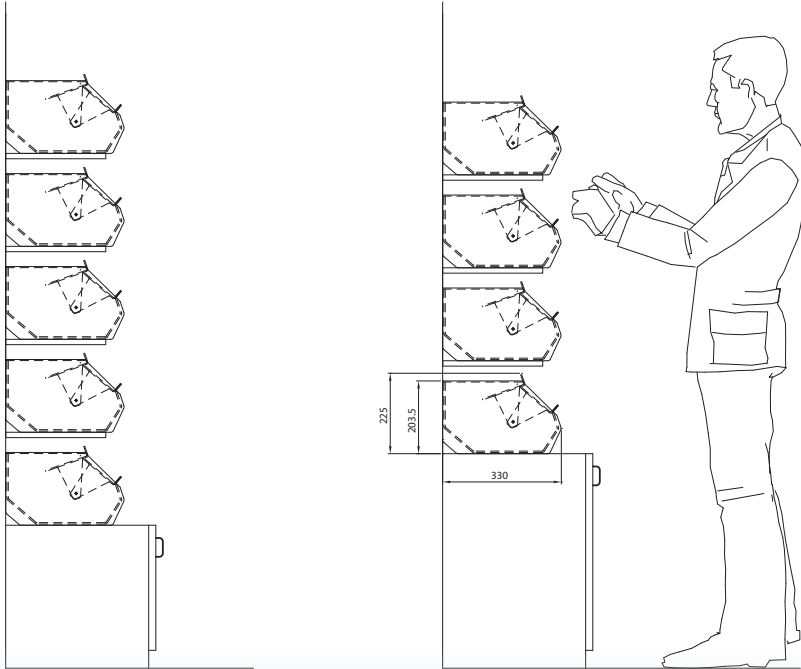

La caramelliera si presta ad essere posizionata in modo sovrapposto ad altre, al fine di costituire una parete distributiva.

Sweet dispensers can be stacked to allow the building of a distribution wall.

