

COLONNINA GUIDAFILA / QUEUE GUIDELINE

## GuideLine

Il sistema di colonnine guidafile a nastro GuideLine è uno strumento indispensabile ed espandibile per l'organizzazione di zone riservate e percorsi prestabiliti.

E' costituito da colonna e base bombata di grande stabilità e con meccanismo avvolgibile a nastro da 3 mt. con possibilità di aggancio fino a 3 nastri per costruire percorsi multipli.

Nella parte superiore possono essere montati gli accessori porta avvisi a tasca piatta o tasca porta depliant in Plexiglas® antiurto trasparente.



Nastro disponibile nei vari colori con possibilità di personalizzazione.  
*Band available in different colours with personalized possibilities.*

*The system band queue guideline GuideLine is an indispensable and expandible tool for the organization of reserved space and pre-arranged routes. It is made of a highly stable column and convex base with roll-up mechanism for the 3 mt belt. It comes complete with hooking possibility for up to 3 belts for building multiple routes.*

*The upper part can be mounted with accessories such as notice-signs /flat pocket poster-signs and brochure pockets in transparent shockproof Plexiglas®*



La **GuideLine-s** è la mini colonnina che si colloca principalmente nei musei, nei saloni automobilistici o spazi espositivi, dove la delimitazione di aree è indispensabile senza intralciare l'esposizione.

*The **GuideLine-s** is a mini column that can be placed principally in museums, in car showrooms or in exhibitor spaces where a limited area is indispensable without constructing the exhibition.*



GUIDAFILA / GUIDELINE

## W-Line WGL

Il sistema a nastro W-line è costituito da un attacco a parete dove inserire il sistema a nastro come descritto nella colonnina GuideLine, con la particolarità di far partire il nastro non solo sul fronte ma anche di lato sinistro, destro e posteriore. Utile per delimitare un' area ristretta ad esempio corridoi, scale ed aree di servizio, può terminare l'aggancio o a parete con l'apposito fissaggio a muro mod. WGL o alla classica colonnina GuideLine.



Nastro disponibile nei vari colori/strisce con possibilità di personalizzazione.  
*The tape is available in different colours/stripes with personalized possibilities.*



*THE BELT SYSTEM W-Line is made of a wall connection where the tape system can be inserted as described in GuideLine column, with the additional advantage that the tape can start not only from the front but also from the left, right and rear side. Useful for delimiting restricted areas like corridors, stairs and service areas, the BELT SYSTEM W - Line can finish the connection or wall with a special wall fixture. Available on WGL or the classic GuideLine.*



COLONNINA GUIDAFILA / QUEUE GUIDELINE

## GuideLine W-Line WGL

Tasca piatta portamessaggio in Plexiglas® antiurto trasparente  
*Flat message pocket in transparent shockproof Plexiglas®*

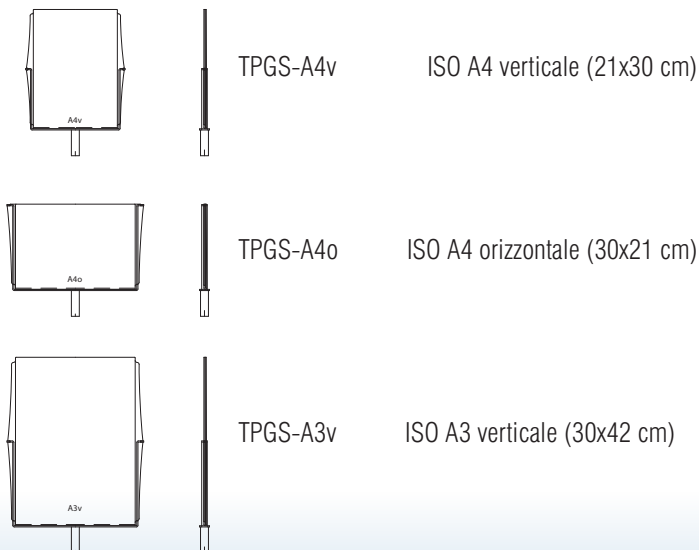

Tasca portadepliant in Plexiglas® antiurto trasparente  
*Brochure pocket in transparent shockproof Plexiglas®*

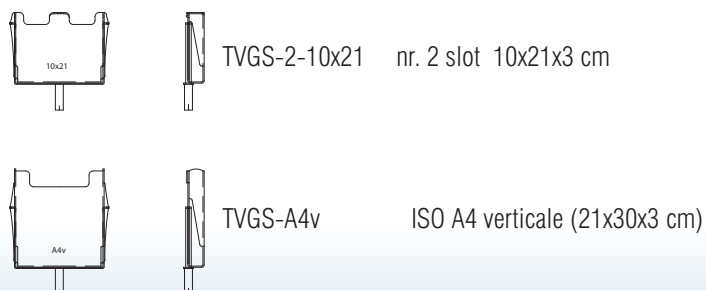

Colori disponibili  
*Available colours*



Cromato lucido / *gloss chromate*



Grigio gofrato metallizzato / *embossed metallic grey*



Canna di fucile / *dark metallic grey*



Personalizzazioni su richiesta / *personalization on request*

GuideLine-S BRV / BRC

Colonnina di guidafila verniciata / cromata  
*Varnished / chromated queue guideline*

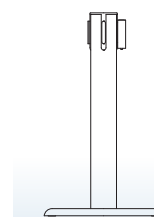

GuideLine BRV / BRC

Colonnina di guidafila verniciata / cromata  
*Varnished / chromated queue guideline*

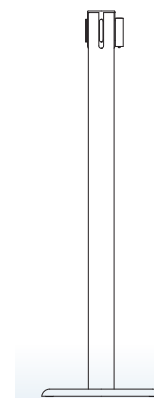

W-Line-V / W-Line-C

Guidafila verniciata / cromata  
*Varnished / chromated guideline*

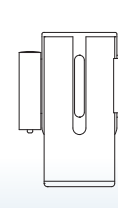

WGL-V / WGL-C

Attacco parete verniciato / cromato  
*Varnished / chromated wall fixture*



COLONNINA GUIDAFILA / QUEUE GUIDELINE

# GuideLine W-Line WGL

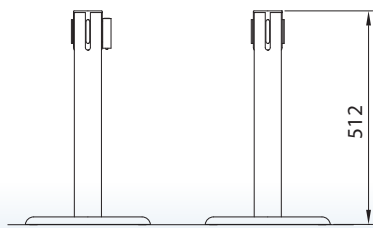

**GuideLine-S**

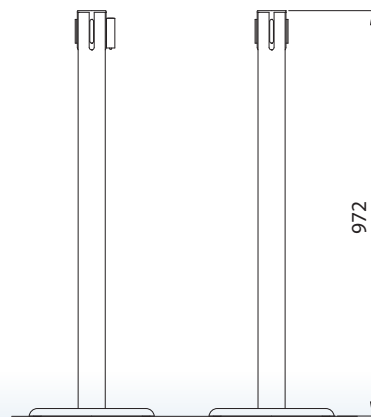

**GuideLine**

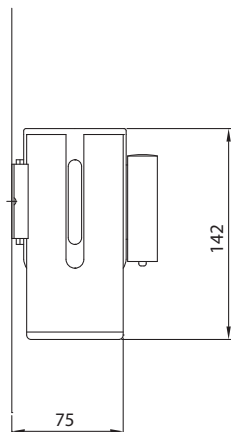
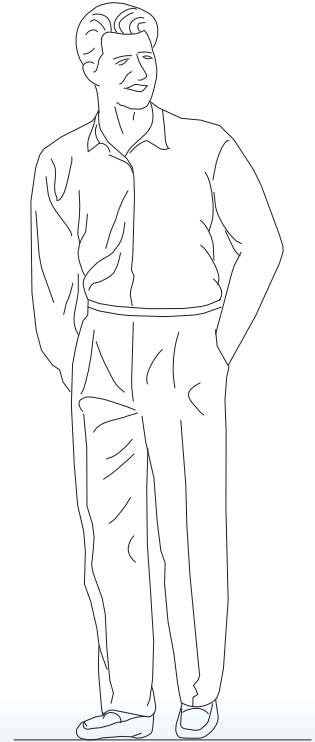

**W-Line**

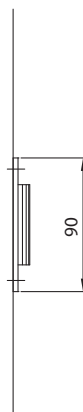

**WGL**

COLONNINA GUIDAFILA / QUEUE GUIDELINE

**GuideLine**

TPGS-A4v  
Tasca piatta portamessaggio ISO A4  
vert.

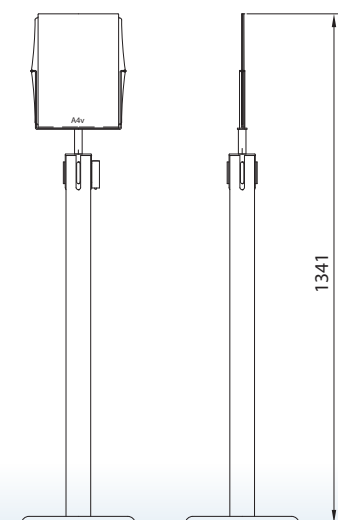

TPGS-A4o  
Tasca piatta portamessaggio ISO A4  
orizz.

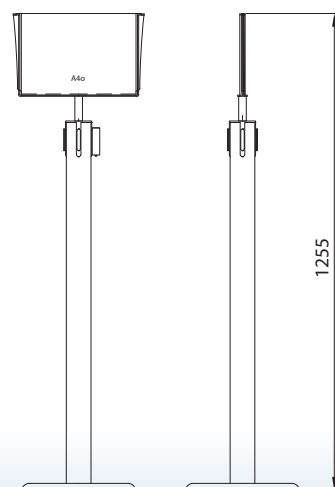

TPGS-A3v  
Tasca piatta portamessaggio ISO A3  
vert.

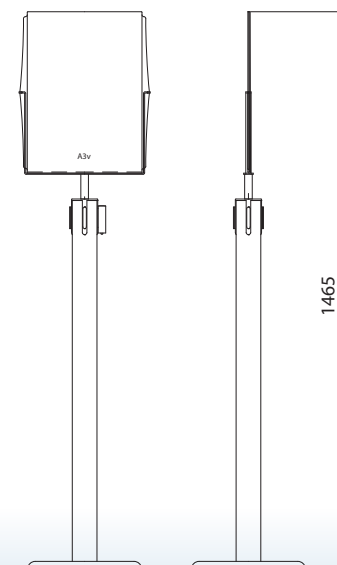

TVGS-2-10x21  
Tasca portadeplianti 1/3 ISO A4  
(10x21)

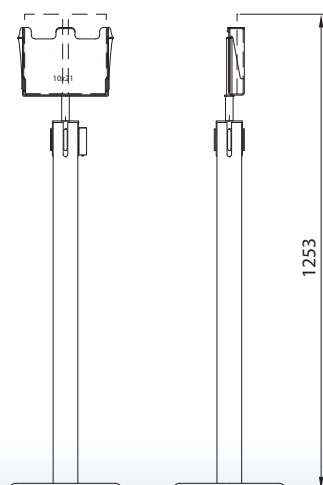

TVGS-A4v  
Tasca portadeplianti ISO A4 vert.

